



DAS HERZ DER FRISCHE

DRY-EXPANSION EVAPORATORS

DP-276-1 EN



SQU SERIES

 HEAT EXCHANGERS

 HFO READY

 AIR CONDITIONING

 PROCESS COOLING

SQD

Application

The new SQD is a single pass dry-expansion evaporator designed for air conditioning and process cooling applications at positive temperature operation. SQD can be used for both medium and high efficiency chiller applications, ensuring the highest possible performance reachable with a dry-expansion evaporator.

Technology

SQD evaporator is optimized for R134a and R1234ze refrigerants and it is compatible with most HFC/HFO refrigerants.

The unique design is including:

- // a new square shell with a patented tube bundle design
- // a new patented multi chamber distribution system

Benefits

SQD evaporator...

- // ensures a more consistent and stable performance with lower water pressure drop compared with other traditional dry expansion evaporators due to the innovative square shell design
- // includes a resistant internal structure to ensure long life reliability at high flow rates
- // features a modular refrigerant distribution system, to be optimized for different operating conditions
- // it is easy to be positioned inside a chiller frame.

Basic features

- // Water connections available with a left or right orientation
- // Available with 1, 2 or 3 independent refrigerant circuits
- // Available with 8 shell sizes from 150 to 500 mm
- // Overall length (L) from 2000 to 4200 mm
- // Cooling capacity up to 2 MW

Standard component materials

- // Shell, tube sheets: carbon steel
- // Refrigerant headers: cast iron; carbon steel
- // Tubes: copper
- // Baffles: plastic polymer

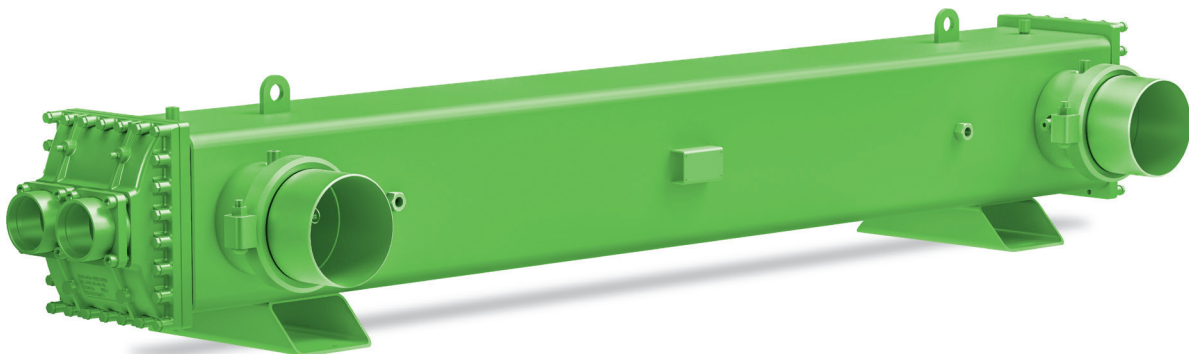

Working principle – evaporator mode

- // The refrigerant runs inside the tubes with one pass configuration
- // The brine flows within the shell side, on the outside of the tubes, in a counter cross flow pattern



Design data

PED (CE) approval

Version	Tube side				Shell side			
	PS (bar)	TS max (°C)	TS min (°C)	TP (bar)	PS (bar)	TS max (°C)	TS min (°C)	TP (bar)
STD	24,5	90	-10	35	10	50	-10	14,3

STD Standard version // PS Maximum allowable pressure // TS max Maximum allowable temperature // TS min Minimum allowable temperature // TP Test Pressure

Denomination

SQD3510208-13-6035-R-CE

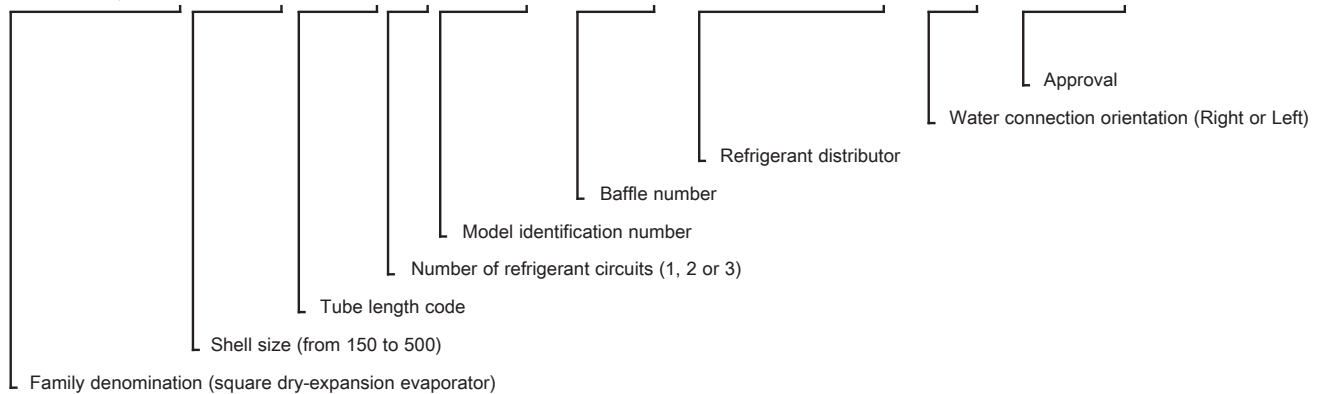

Available on request

- // Support feet
- // Welded flanges and Victaulic flanges
- // 19 mm thermal insulation
- // Antifreeze electrical heater
- // SELO, EAC approvals



SQD model data table

150 size

Model	Total length	Shell diameter	Header height	Header width	Water connections	Welded supports	Refrigerant inlet	Refrigerant outlet	Water connections	Refrigerant-side volume	Water-side volume	Weight
	A mm	B mm	C mm	E mm	G mm	H mm	R1/R2	R3/R4	W1/W2	dm ³	dm ³	kg
SQD1506202	1943	150	195	195	1562	1100	FL37-OD28	FL55-OD54	3" (flexible joint)	9	32	109
SQD1506203	1943	150	195	195	1562	1100				11	30	112
SQD1506204	1943	150	195	195	1562	1100				13	28	114
SQD1507202	2343	150	195	195	1962	1500				10	39	120
SQD1507203	2343	150	195	195	1962	1500				12	36	124
SQD1507204	2343	150	195	195	1962	1500				15	34	127
SQD1508202	2643	150	195	195	2262	1800				10	44	128
SQD1508203	2643	150	195	195	2262	1800				13	41	132
SQD1508204	2643	150	195	195	2262	1800				16	38	136
SQD1509202	2893	150	195	195	2512	2100				11	48	135
SQD1509203	2893	150	195	195	2512	2100				14	45	140
SQD1509204	2893	150	195	195	2512	2100				17	42	144
SQD1510202	3148	150	195	195	2767	2300				12	53	142
SQD1510203	3148	150	195	195	2767	2300				15	49	147
SQD1510204	3148	150	195	195	2767	2300				18	45	152
SQD1511202	3443	150	195	195	3062	2500				12	58	150
SQD1511203	3443	150	195	195	3062	2500				16	54	156
SQD1511204	3443	150	195	195	3062	2500				19	50	161
SQD1512202	3743	150	195	195	3362	2700				13	63	159
SQD1512203	3743	150	195	195	3362	2700				17	58	165
SQD1512204	3743	150	195	195	3362	2700				21	54	171
SQD1513202	4043	150	195	195	3662	3000				13	68	167
SQD1513203	4043	150	195	195	3662	3000				18	63	174
SQD1513204	4043	150	195	195	3662	3000				22	58	180

200 size

SQD2006204	1959	200	250	230	1537	1100	FL37-OD28	FL70-OD67	4" (flexible joint)	17	54	172
SQD2006205	1959	200	250	230	1537	1100				20	51	176
SQD2006206	1959	200	250	230	1537	1100				22	48	178
SQD2007204	2359	200	250	230	1937	1500				19	65	191
SQD2007205	2359	200	250	230	1937	1500				23	61	196
SQD2007206	2359	200	250	230	1937	1500				26	58	200
SQD2008204	2659	200	250	230	2237	1800				21	74	206
SQD2008205	2659	200	250	230	2237	1800				25	69	211
SQD2008206	2659	200	250	230	2237	1800				28	66	216
SQD2009204	2909	200	250	230	2487	2100				22	81	218
SQD2009205	2909	200	250	230	2487	2100				27	76	224
SQD2009206	2909	200	250	230	2487	2100				30	72	229
SQD2010204	3164	200	250	230	2742	2300				24	88	230
SQD2010205	3164	200	250	230	2742	2300				28	83	237
SQD2010206	3164	200	250	230	2742	2300				33	78	242
SQD2011204	3459	200	250	230	3037	2500				26	97	244
SQD2011205	3459	200	250	230	3037	2500				30	91	252
SQD2011206	3459	200	250	230	3037	2500				35	86	258
SQD2012204	3759	200	250	230	3337	2700				27	105	259
SQD2012205	3759	200	250	230	3337	2700				33	99	268
SQD2012206	3759	200	250	230	3337	2700				38	93	275
SQD2013204	4059	200	250	230	3637	3000				29	114	274
SQD2013205	4059	200	250	230	3637	3000				35	107	284
SQD2013206	4059	200	250	230	3637	3000				40	101	291

Dimensional data referring to double refrigerant circuit models – please see technical drawing on page 11.

250 size

Model	Total length	Shell diameter	Header height	Header width	Water connections	Welded supports	Refrigerant inlet	Refrigerant outlet	Water connections	Refrigerant-side volume	Water-side volume	Weight
	A mm	B mm	C mm	E mm	G mm	H mm	R1/R2	R3/R4	W1/W2	dm ³	dm ³	kg
SQD2506205	1974	250	305	280	1511	1100	FL55-OD35	FL70-OD76	5" (flexible joint)	25	83	263
SQD2506206	1974	250	305	280	1511	1100				28	80	267
SQD2506207	1974	250	305	280	1511	1100				31	76	272
SQD2506208	1974	250	305	280	1511	1100				34	73	277
SQD2507205	2374	250	305	280	1911	1500				28	101	294
SQD2507206	2374	250	305	280	1911	1500				32	97	299
SQD2507207	2374	250	305	280	1911	1500				36	92	305
SQD2507208	2374	250	305	280	1911	1500				40	88	311
SQD2508205	2674	250	305	280	2211	1800				31	115	317
SQD2508206	2674	250	305	280	2211	1800				35	110	323
SQD2508207	2674	250	305	280	2211	1800				40	105	330
SQD2508208	2674	250	305	280	2211	1800				44	100	337
SQD2509205	2924	250	305	280	2461	2100				33	126	336
SQD2509206	2924	250	305	280	2461	2100				38	120	343
SQD2509207	2924	250	305	280	2461	2100				43	115	351
SQD2509208	2924	250	305	280	2461	2100				38	109	358
SQD2510205	3179	250	305	280	2716	2300				35	137	355
SQD2510206	3179	250	305	280	2716	2300				40	131	363
SQD2510207	3179	250	305	280	2716	2300				46	125	372
SQD2510208	3179	250	305	280	2716	2300				51	119	380
SQD2511205	3474	250	305	280	3011	2500				38	150	377
SQD2511206	3474	250	305	280	3011	2500				43	144	386
SQD2511207	3474	250	305	280	3011	2500				50	137	396
SQD2511208	3474	250	305	280	3011	2500				55	130	405
SQD2512205	3774	250	305	280	3311	2700				41	164	400
SQD2512206	3774	250	305	280	3311	2700				47	157	410
SQD2512207	3774	250	305	280	3311	2700				53	149	420
SQD2512208	3774	250	305	280	3311	2700				60	142	430
SQD2513205	4074	250	305	280	3611	3000				43	177	424
SQD2513206	4074	250	305	280	3611	3000				50	170	434
SQD2513207	4074	250	305	280	3611	3000				57	161	446
SQD2513208	4074	250	305	280	3611	3000				64	154	456

Dimensional data referring to double refrigerant circuit models – please see technical drawing on page 11.



SQD model data table

300 size

Model	Total length	Shell diameter	Header height	Header width	Water connections	Welded supports	Refrigerant inlet	Refrigerant outlet	Water connections	Refrigerant-side volume	Water-side volume	Weight
	A mm	B mm	C mm	E mm	G mm	H mm	R1/R2	R3/R4	W1/W2	dm ³	dm ³	kg
SQD3006207	1990	300	350	300	1500	1100	FL55-OD42	FL90-OD89	6" (flexible joint)	38	112	327
SQD3006208	1990	300	350	300	1500	1100				42	107	331
SQD3006209	1990	300	350	300	1500	1100				46	103	337
SQD3006210	1990	300	350	300	1500	1100				50	98	342
SQD3007207	2390	300	350	300	1900	1500				44	138	377
SQD3007208	2390	300	350	300	1900	1500				49	132	383
SQD3007209	2390	300	350	300	1900	1500				54	127	390
SQD3007210	2390	300	350	300	1900	1500				59	121	397
SQD3008207	2690	300	350	300	2200	1800				49	156	412
SQD3008208	2690	300	350	300	2200	1800				54	150	419
SQD3008209	2690	300	350	300	2200	1800				60	143	428
SQD3008210	2690	300	350	300	2200	1800				66	137	436
SQD3009207	2940	300	350	300	2450	2100				53	171	441
SQD3009208	2940	300	350	300	2450	2100				59	164	449
SQD3009209	2940	300	350	300	2450	2100				65	157	459
SQD3009210	2940	300	350	300	2450	2100				71	150	468
SQD3010207	3195	300	350	300	2705	2300				57	186	471
SQD3010208	3195	300	350	300	2705	2300				63	179	480
SQD3010209	3195	300	350	300	2705	2300				70	171	490
SQD3010210	3195	300	350	300	2705	2300				77	164	500
SQD3011207	3490	300	350	300	3000	2500				61	204	506
SQD3011208	3490	300	350	300	3000	2500				68	196	516
SQD3011209	3490	300	350	300	3000	2500				76	188	527
SQD3011210	3490	300	350	300	3000	2500				83	180	538
SQD3012207	3790	300	350	300	3300	2700				66	223	541
SQD3012208	3790	300	350	300	3300	2700				74	214	552
SQD3012209	3790	300	350	300	3300	2700				82	205	565
SQD3012210	3790	300	350	300	3300	2700				90	196	577
SQD3013207	4090	300	350	300	3600	3000				70	241	579
SQD3013208	4090	300	350	300	3600	3000				79	231	591
SQD3013209	4090	300	350	300	3600	3000				88	221	605
SQD3013210	4090	300	350	300	3600	3000				96	212	618

Dimensional data referring to double refrigerant circuit models – please see technical drawing on page 11.

350 size

Model	Total length	Shell diameter	Header height	Header width	Water connections	Welded supports	Refrigerant inlet	Refrigerant outlet	Water connections	Refrigerant-side volume	Water-side volume	Weight
	A mm	B mm	C mm	E mm	G mm	H mm	R1/R2	R3/R4	W1/W2	dm ³	dm ³	kg
SQD3506208	2003	350	400	350	1462	1100	FL55-OD42	FL112-OD108	6" (flexible joint)	49	158	419
SQD3506209	2003	350	400	350	1462	1100				54	152	426
SQD3506210	2003	350	400	350	1462	1100				58	147	431
SQD3506211	2003	350	400	350	1462	1100				63	142	438
SQD3506212	2003	350	400	350	1462	1100				68	137	443
SQD3507208	2403	350	400	350	1862	1500				57	192	477
SQD3507209	2403	350	400	350	1862	1500				63	185	485
SQD3507210	2403	350	400	350	1862	1500				68	179	492
SQD3507211	2403	350	400	350	1862	1500				74	173	501
SQD3507212	2403	350	400	350	1862	1500				80	166	508
SQD3508208	2703	350	400	350	2162	1800				63	221	528
SQD3508209	2703	350	400	350	2162	1800				70	214	538
SQD3508210	2703	350	400	350	2162	1800				76	207	546
SQD3508211	2703	350	400	350	2162	1800				82	199	556
SQD3508212	2703	350	400	350	2162	1800				89	192	564
SQD3509208	2953	350	400	350	2412	2100				68	243	564
SQD3509209	2953	350	400	350	2412	2100				75	235	575
SQD3509210	2953	350	400	350	2412	2100				82	227	584
SQD3509211	2953	350	400	350	2412	2100			89	219	595	
SQD3509212	2953	350	400	350	2412	2100			96	211	604	
SQD3510208	3208	350	400	350	2667	2300			73	264	601	
SQD3510209	3208	350	400	350	2667	2300			81	256	613	
SQD3510210	3208	350	400	350	2667	2300			89	247	623	
SQD3510211	3208	350	400	350	2667	2300			97	238	635	
SQD3510212	3208	350	400	350	2667	2300			104	230	645	
SQD3511208	3503	350	400	350	2962	2500			79	290	643	
SQD3511209	3503	350	400	350	2962	2500			88	280	656	
SQD3511210	3503	350	400	350	2962	2500			96	271	668	
SQD3511211	3503	350	400	350	2962	2500			105	261	681	
SQD3511212	3503	350	400	350	2962	2500			113	251	693	
SQD3512208	3803	350	400	350	3262	2700			85	315	686	
SQD3512209	3803	350	400	350	3262	2700			95	305	701	
SQD3512210	3803	350	400	350	3262	2700			104	294	714	
SQD3512211	3803	350	400	350	3262	2700			113	284	728	
SQD3512212	3803	350	400	350	3262	2700			122	274	741	
SQD3513208	4103	350	400	350	3562	3000			91	341	734	
SQD3513209	4103	350	400	350	3562	3000			101	330	749	
SQD3513210	4103	350	400	350	3562	3000			111	318	764	
SQD3513211	4103	350	400	350	3562	3000			121	307	780	
SQD3513212	4103	350	400	350	3562	3000			131	296	794	

Dimensional data referring to double refrigerant circuit models – please see technical drawing on page 11.



SQD model data table

400 size

Model	Total length	Shell diameter	Header height	Header width	Water connections	Welded supports	Refrigerant inlet	Refrigerant outlet	Water connections	Refrigerant-side volume	Water-side volume	Weight
	A mm	B mm	C mm	E mm	G mm	H mm	R1/R2	R3/R4	W1/W2	dm ³	dm ³	kg
SQD4006209	2018	400	470	430	1410	1100	FL55-OD42	FL140-OD133	8" (flexible joint)	61	205	593
SQD4006210	2018	400	470	430	1410	1100				66	199	599
SQD4006211	2018	400	470	430	1410	1100				72	193	606
SQD4006212	2018	400	470	430	1410	1100				77	188	612
SQD4006213	2018	400	470	430	1410	1100				82	182	619
SQD4006214	2018	400	470	430	1410	1100				87	176	625
SQD4007209	2418	400	470	430	1810	1500				71	249	671
SQD4007210	2418	400	470	430	1810	1500				78	242	679
SQD4007211	2418	400	470	430	1810	1500				84	235	688
SQD4007212	2418	400	470	430	1810	1500				91	228	696
SQD4007213	2418	400	470	430	1810	1500				97	221	705
SQD4007214	2418	400	470	430	1810	1500				103	214	713
SQD4008209	2718	400	470	430	2110	1800				79	283	730
SQD4008210	2718	400	470	430	2110	1800				86	275	740
SQD4008211	2718	400	470	430	2110	1800				94	266	750
SQD4008212	2718	400	470	430	2110	1800				101	258	759
SQD4008213	2718	400	470	430	2110	1800				108	250	770
SQD4008214	2718	400	470	430	2110	1800				115	242	779
SQD4009209	2968	400	470	430	2360	2100				86	310	779
SQD4009210	2968	400	470	430	2360	2100				93	301	790
SQD4009211	2968	400	470	430	2360	2100				102	292	802
SQD4009212	2968	400	470	430	2360	2100				109	283	812
SQD4009213	2968	400	470	430	2360	2100				118	274	824
SQD4009214	2968	400	470	430	2360	2100				126	265	834
SQD4010209	3223	400	470	430	2615	2300				92	338	829
SQD4010210	3223	400	470	430	2615	2300				101	329	841
SQD4010211	3223	400	470	430	2615	2300				110	319	854
SQD4010212	3223	400	470	430	2615	2300				118	309	866
SQD4010213	3223	400	470	430	2615	2300				127	299	879
SQD4010214	3223	400	470	430	2615	2300				136	289	891
SQD4011209	3518	400	470	430	2910	2500				100	371	887
SQD4011210	3518	400	470	430	2910	2500				109	360	900
SQD4011211	3518	400	470	430	2910	2500				119	349	915
SQD4011212	3518	400	470	430	2910	2500				128	339	928
SQD4011213	3518	400	470	430	2910	2500				138	328	943
SQD4011214	3518	400	470	430	2910	2500				148	317	956
SQD4012209	3818	400	470	430	3210	2700				108	404	950
SQD4012210	3818	400	470	430	3210	2700				118	393	965
SQD4012211	3818	400	470	430	3210	2700				128	381	981
SQD4012212	3818	400	470	430	3210	2700				139	369	996
SQD4012213	3818	400	470	430	3210	2700				149	357	1012
SQD4012214	3818	400	470	430	3210	2700				160	345	1027
SQD4013209	4118	400	470	430	3510	3000	115	438	1009			
SQD4013210	4118	400	470	430	3510	3000	126	425	1025			
SQD4013211	4118	400	470	430	3510	3000	138	412	1043			
SQD4013212	4118	400	470	430	3510	3000	149	399	1059			
SQD4013213	4118	400	470	430	3510	3000	161	386	1077			
SQD4013214	4118	400	470	430	3510	3000	172	374	1093			

Dimensional data referring to double refrigerant circuit models – please see technical drawing on page 11.

450 size

Model	Total length	Shell diameter	Header height	Header width	Water connections	Welded supports	Refrigerant inlet	Refrigerant outlet	Water connections	Refrigerant-side volume	Water-side volume	Weight
	A mm	B mm	C mm	E mm	G mm	H mm	R1/R2	R3/R4	W1/W2	dm ³	dm ³	kg
SQD4506211	2028	450	520	450	1410	1100	FL70-OD54	FL140-OD133	8" (flexible joint)	82	250	745
SQD4506212	2028	450	520	450	1410	1100				87	243	753
SQD4506213	2028	450	520	450	1410	1100				94	236	760
SQD4506214	2028	450	520	450	1410	1100				100	229	768
SQD4506215	2028	450	520	450	1410	1100				106	223	775
SQD4506216	2028	450	520	450	1410	1100				112	216	783
SQD4507211	2428	450	520	450	1810	1500				96	304	848
SQD4507212	2428	450	520	450	1810	1500				103	296	858
SQD4507213	2428	450	520	450	1810	1500				111	287	867
SQD4507214	2428	450	520	450	1810	1500				118	279	878
SQD4507215	2428	450	520	450	1810	1500				125	271	887
SQD4507216	2428	450	520	450	1810	1500				133	263	897
SQD4508211	2728	450	520	450	2030	1800				107	350	942
SQD4508212	2728	450	520	450	2030	1800				115	341	954
SQD4508213	2728	450	520	450	2030	1800				123	331	965
SQD4508214	2728	450	520	450	2030	1800				132	322	977
SQD4508215	2728	450	520	450	2030	1800			140	312	988	
SQD4508216	2728	450	520	450	2030	1800			148	303	1000	
SQD4509211	2978	450	520	450	2280	2100			116	384	1006	
SQD4509212	2978	450	520	450	2280	2100			125	374	1019	
SQD4509213	2978	450	520	450	2280	2100			134	363	1032	
SQD4509214	2978	450	520	450	2280	2100			143	353	1045	
SQD4509215	2978	450	520	450	2280	2100			153	343	1058	
SQD4509216	2978	450	520	450	2280	2100			162	332	1071	
SQD4510211	3233	450	520	450	2535	2300			125	419	1071	
SQD4510212	3233	450	520	450	2535	2300			135	408	1086	
SQD4510213	3233	450	520	450	2535	2300			145	396	1100	
SQD4510214	3233	450	520	450	2535	2300			155	385	1115	
SQD4510215	3233	450	520	450	2535	2300			165	373	1129	
SQD4510216	3233	450	520	450	2535	2300			175	362	1143	
SQD4511211	3528	450	520	450	2830	2500			136	459	1150	
SQD4511212	3528	450	520	450	2830	2500			146	447	1167	
SQD4511213	3528	450	520	450	2830	2500			158	434	1183	
SQD4511214	3528	450	520	450	2830	2500			169	422	1190	
SQD4511215	3528	450	520	450	2830	2500			180	409	1215	
SQD4511216	3528	450	520	450	2830	2500			190	397	1232	
SQD4512211	3828	450	520	450	3130	2700			146	500	1227	
SQD4512212	3828	450	520	450	3130	2700			158	486	1246	
SQD4512213	3828	450	520	450	3130	2700			170	472	1263	
SQD4512214	3828	450	520	450	3130	2700			182	459	1281	
SQD4512215	3828	450	520	450	3130	2700	194	445	1299			
SQD4512216	3828	450	520	450	3130	2700	206	432	1317			
SQD4513211	4128	450	520	450	3430	3000	157	540	1304			
SQD4513212	4128	450	520	450	3430	3000	170	526	1324			
SQD4513213	4128	450	520	450	3430	3000	183	511	1343			
SQD4513214	4128	450	520	450	3430	3000	196	496	1363			
SQD4513215	4128	450	520	450	3430	3000	209	482	1383			
SQD4513216	4128	450	520	450	3430	3000	222	467	1402			

Dimensional data referring to double refrigerant circuit models – please see technical drawing on page 11.



SQD model data table

500 size

Model	Total length	Shell diameter	Header height	Header width	Water connections	Welded supports	Refrigerant inlet	Refrigerant outlet	Water connections	Refrigerant-side volume	Water-side volume	Weight
	A mm	B mm	C mm	E mm	G mm	H mm	R1/R2	R3/R4	W1/W2	dm ³	dm ³	kg
SQD5006212	2041	500	570	530	1330	1100	FL70-OD67	FL160-OD168	10" (flexible joint)	96	312	948
SQD5006213	2041	500	570	530	1330	1100				103	305	956
SQD5006214	2041	500	570	530	1330	1100				109	297	964
SQD5006215	2041	500	570	530	1330	1100				116	290	973
SQD5006216	2041	500	570	530	1330	1100				123	283	980
SQD5006217	2041	500	570	530	1330	1100				129	275	989
SQD5006218	2041	500	570	530	1330	1100				136	268	996
SQD5007212	2441	500	570	530	1730	1500				113	380	1076
SQD5007213	2441	500	570	530	1730	1500				121	371	1087
SQD5007214	2441	500	570	530	1730	1500				129	362	1097
SQD5007215	2441	500	570	530	1730	1500				138	353	1108
SQD5007216	2441	500	570	530	1730	1500				146	344	1118
SQD5007217	2441	500	570	530	1730	1500				154	334	1130
SQD5007218	2441	500	570	530	1730	1500				162	325	1140
SQD5008212	2741	500	570	530	2030	1800				126	431	1170
SQD5008213	2741	500	570	530	2030	1800				135	420	1183
SQD5008214	2741	500	570	530	2030	1800				144	410	1195
SQD5008215	2741	500	570	530	2030	1800				154	400	1208
SQD5008216	2741	500	570	530	2030	1800				163	389	1220
SQD5008217	2741	500	570	530	2030	1800				172	379	1233
SQD5008218	2741	500	570	530	2030	1800				181	369	1245
SQD5009212	2991	500	570	530	2280	2100				137	473	1249
SQD5009213	2991	500	570	530	2280	2100				147	462	1264
SQD5009214	2991	500	570	530	2280	2100				157	450	1277
SQD5009215	2991	500	570	530	2280	2100				167	439	1292
SQD5009216	2991	500	570	530	2280	2100				177	428	1305
SQD5009217	2991	500	570	530	2280	2100				187	416	1320
SQD5009218	2991	500	570	530	2280	2100				197	405	1333
SQD5010212	3246	500	570	530	2535	2300				147	516	1329
SQD5010213	3246	500	570	530	2535	2300				159	504	1345
SQD5010214	3246	500	570	530	2535	2300				170	491	1360
SQD5010215	3246	500	570	530	2535	2300				181	479	1377
SQD5010216	3246	500	570	530	2535	2300				192	466	1392
SQD5010217	3246	500	570	530	2535	2300				203	454	1408
SQD5010218	3246	500	570	530	2535	2300				214	441	1423
SQD5011212	3541	500	570	530	2830	2500				160	566	1422
SQD5011213	3541	500	570	530	2830	2500				172	552	1440
SQD5011214	3541	500	570	530	2830	2500				184	539	1457
SQD5011215	3541	500	570	530	2830	2500				197	525	1475
SQD5011216	3541	500	570	530	2830	2500				209	511	1492
SQD5011217	3541	500	570	530	2830	2500	221	498	1510			
SQD5011218	3541	500	570	530	2830	2500	233	484	1527			
SQD5012212	3841	500	570	530	3130	2700	173	617	1521			
SQD5012213	3841	500	570	530	3130	2700	186	602	1541			
SQD5012214	3841	500	570	530	3130	2700	199	587	1560			
SQD5012215	3841	500	570	530	3130	2700	213	572	1580			
SQD5012216	3841	500	570	530	3130	2700	226	557	1598			
SQD5012217	3841	500	570	530	3130	2700	239	542	1619			
SQD5012218	3841	500	570	530	3130	2700	252	527	1637			
SQD5013212	4141	500	570	530	3430	3000	186	668	1615			
SQD5013213	4141	500	570	530	3430	3000	200	651	1637			
SQD5013214	4141	500	570	530	3430	3000	214	635	1658			
SQD5013215	4141	500	570	530	3430	3000	229	610	1680			
SQD5013216	4141	500	570	530	3430	3000	243	603	1700			
SQD5013217	4141	500	570	530	3430	3000	258	587	1722			
SQD5013218	4141	500	570	530	3430	3000	272	571	1743			

Dimensional data referring to double refrigerant circuit models – please see technical drawing on page 11.

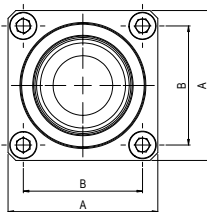
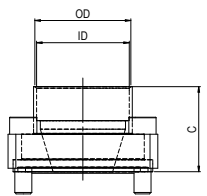
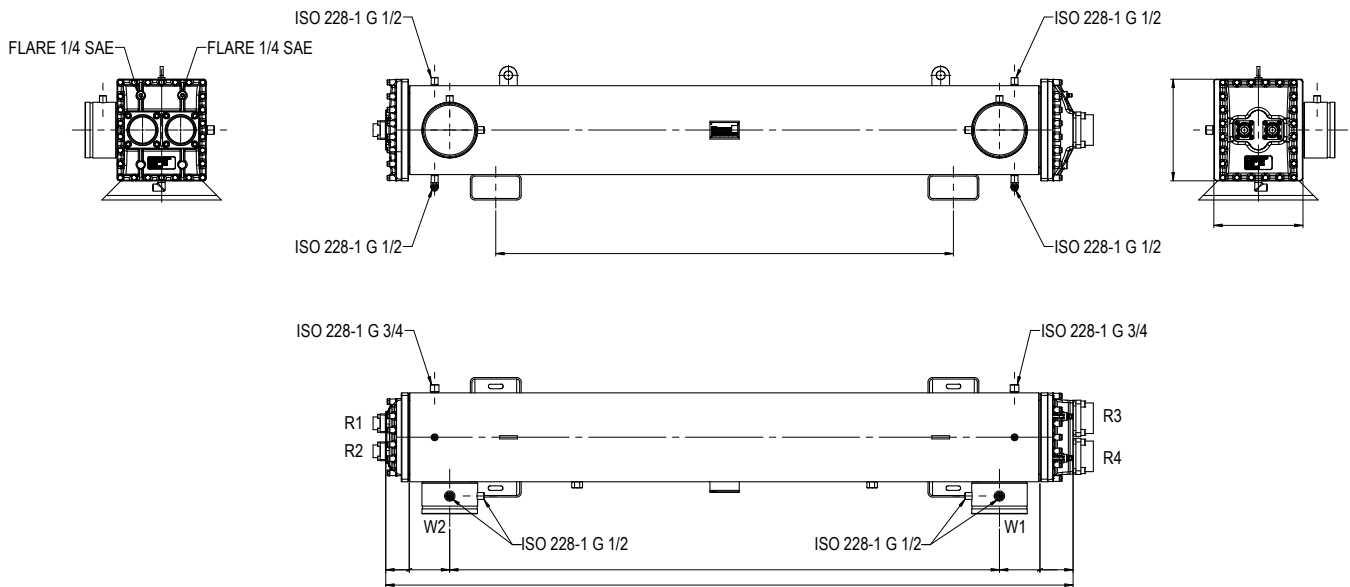

Flange refrigerant connection							
Type	A mm	B mm	C mm	OD mm	ID mm	Copper tube	
						ODS (mm)	ODS (inch)
FL37-OD28	54	37	40	33	28,2	28	1 1/8"
FL55-OD35	74	55	50	42	35,3	35	1 3/8"
FL55-OD42	74	55	50	50	42,4	42	1 5/8"
FL55-OD54	74	55	50	58	54,4	54	2 1/8"
FL70-OD54	88	70	50	58	54,4	54	2 1/8"
FL70-OD67	88	70	50	72	67,2	66,7	2 5/8"
FL70-OD76	97	70	50	81	76,4	76	3 1/8"
FL90-OD89	110	90	50	94	89,5	89	3 1/2"
FL112-OD108	142	112	80	120	108,4	108	4 1/4"
FL140-OD133	178	140	80	142	133,5	133	5 1/4"
FL160-OD168	208	160	80	178	169	168	6 5/8"

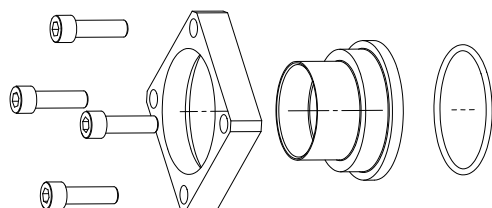



BITZER Kühlmaschinenbau GmbH
Peter-Schaufler-Platz 1 // 71065 Sindelfingen // Germany
Tel +49 7031 932-0 // Fax +49 7031 932-147
bitzer@bitzer.de // www.bitzer.de

Subject to change // 80193201 // 02.2019